



HRA-6000 Series

User/Installation Manual

Guide to Intelligent Parking



Manufacturer:
COMMERCIAL ELECTRONICS
264 HAYDONS ROAD, WIMBLEDON, LONDON SW19 8TT. UK

TEL: +44 020 8404 7105 FAX: +44 020 8404 7104
<http://www.hawkcaralarm.com> e-mail: info@hawkcaralarm.com

**THIS INSTRUCTION MANUAL IS IMPORTANT.
PLEASE READ IT BEFORE INSTALLING THE UNIT.**

Introduction

Congratulation on your purchase of the HAWK Reversing Angel back up sensor, designed to aid operation when backing up your vehicle. Please read carefully before using and understand the features and limitations of this product, keep this manual in the glove compartment. This manual contains important information on safety operations of the backup sensors, it is important that you get familiarized with all functions and descriptions, and follow the recommendations listed so you can make your experience safer and enjoyable.

The System

The sensors activate automatically when vehicle gear is in reverse position (vehicle ignition must be ON in order for the system to operate.)

Sensors are designed to provide a warning when it detects an object as the vehicle is backing up (reverse) at slow speed. You must be aware that the sensors may not detect some objects depending on the size, shape, material or position. Remember that even with backup sensors the driver is responsible for the path to be clear when backing up (when operating vehicle in reverse).



Warning: Improper use of the backup sensor could result in injury or death! This back up sensor is strictly a drive assist device. It is not a substitute of driver's responsibilities when backing up the vehicle. Please drive carefully and follow all local and EU laws when backing up your vehicle. Commercial Electronics does not guarantee or assume any liability for injuries or damage that occurs while backing your vehicle. This product should not be considered a safety device for any purpose. Proper driving skills, including slowing down, using your mirrors and having another person as a visual assist are all proper precautions to be taken in order to safely back your vehicle.

- Changes or modifications to this unit not expressly approved by the party responsible for compliance will void the user's authority to operate the equipment. Any change(s) to the equipment will void CE compliance.

Specifications

- Rated voltage: DC12v
- Operating Voltage: 9V to 18V
- Temperature: -30 °C - +80 °C
- Rated current: 20mA – 200mA
- Detecting distance: 7.8" – 70" (0.2-1.8m)
- Displaying distance: 15" – 70" (0.3-1.8m)
- Ultrasonic frequency: 40Khz

What is Included

- ECU (Electronic Control Unit)
- LED display Roof or Dash mounted (Optional)
- Ultrasonic sensors
- Ultrasonicsensorconnectioncables
- Hole saw
- User manual

How it works

The functions of the sensors depend on an ultrasonic signal that is transmitted by them. They calculate the distance between the object and the sensor by measuring the time it takes for the waves to return after reflecting on the object. This system is designed to give you a visual and auditory signal when the rear bumper of your car is getting close to an object.

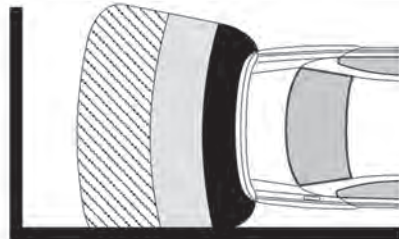
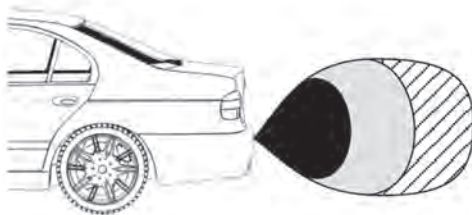
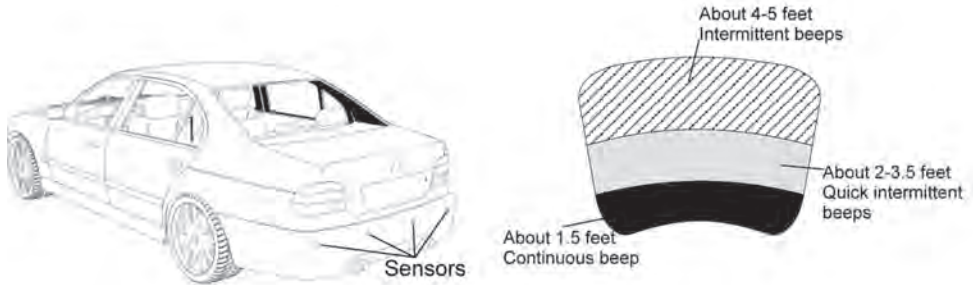

In this example, the right sensor is detecting a wall



If a trailer is attached to the vehicle the system will sound continuously while shift is on reverse position. To avoid sound, simply lower the volume.



The sensor may not detect another vehicle bumper if it is too high.



The sensors are designed to detect only the closest object and this may vary when vehicle is backing up.

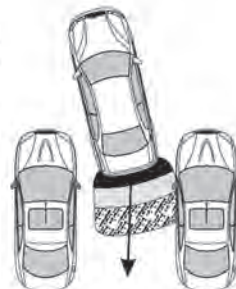

Limitations

The system could malfunction at these temperatures: below -22 Fahrenheit (-30 Celsius) or above 176 Fahrenheit (80 Celsius).

The sensors may not work if an object does not reflect the ultrasonic waves or it has an unusual shape, pole cardboard carton, tire of bicycle, small or slender tree, rectangular lumber or curbs tone. The sensor may not detect another vehicle bumper if it's too high.

Also note: This system has different detection distance to the different object. To the wall, the max detection distance is 1.8m; to the human body, the max detection distance is 1.0m; to the column \square 40cm, the max detection distance is 1.2m.



If the vehicle is equipped with high-power radio antenna.

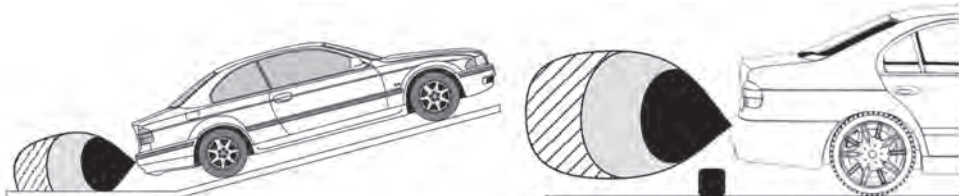

When backing up downhill

If there is a very small object.

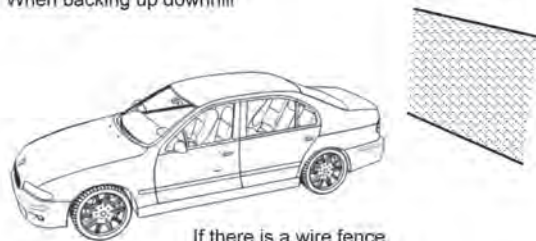

If there is a wire fence.



Backing up in heavy rain or snow.

How to test



Warning: Do not stand behind a moving vehicle death or injury could occur.

Apply the hand brake.



Turn ignition on (Do not start the vehicle)

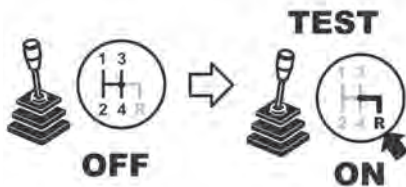

Place the shift gear to reverse position.

From behind the vehicle proceed to check the system by placing the palm of your hand slowly back and forth in front of each sensor. Note: make sure you check all of them.



Note: the distance displayed on the screen is approximate.

Awareness	Distance	Sound	Digital Display	LED Indicator
Safe Mode	100-180cm	Bi...Bi...	1.0-1.8	Green
Alarm Mode	40-90cm	Bi.Bi	0.4-0.9	Yellow
Danger Mode	0-30cm	Biiii	0.0	Red

Maintenance

Always keep sensor from dirt, snow and mud, clean them with a soft towel and low pressure water.

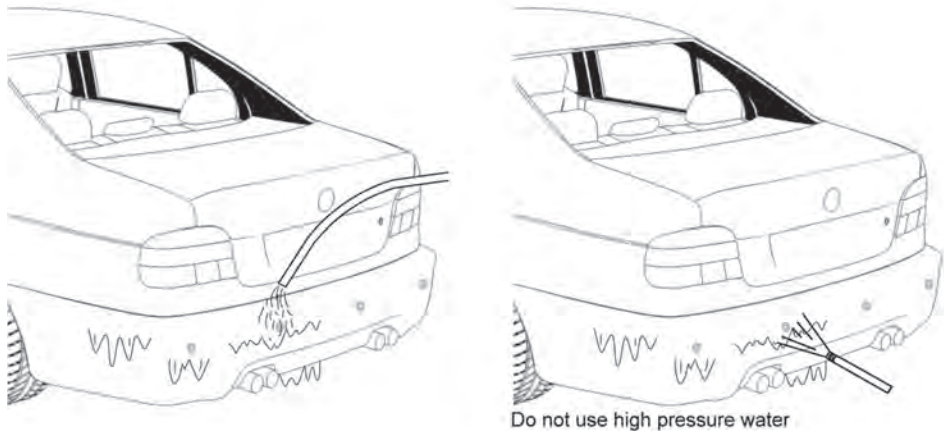

Self-Test function(Model# HRA-5300L)

The back-up system only activates when the vehicle is placed in reverse gear. When placed in reverse gear the system first does a diagnostic check to ensure the system is fully functional and reports any sensor malfunctions within the back- up system. If there is any malfunction with the sensors, the LED display (optional) will show following error message and buzzer will sound.

Number 1 displayed means sensor number 1 is faulty and buzzer will sound once

Number 2 displayed means sensor number 2 is faulty and buzzer will sound twice.

Number 3 displayed means sensor number 3 is faulty and buzzer will sound 3 times.

Number 4 displayed means sensor number 4 is faulty and buzzer will sound 4 times.

Installation Instructions



Note: Before installing system let the components of the exhaust system cool down. This will make the installation safer and preclude heat damage to the backup sensor wiring or components.

Installation Diagram

The following illustration shows the general location of the components of the backup system.

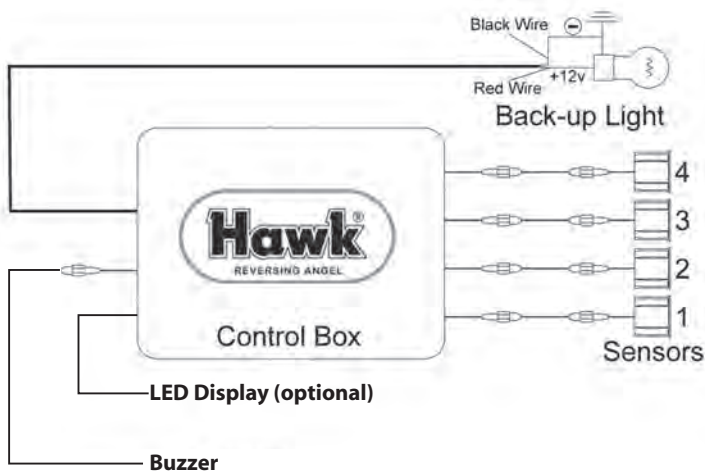
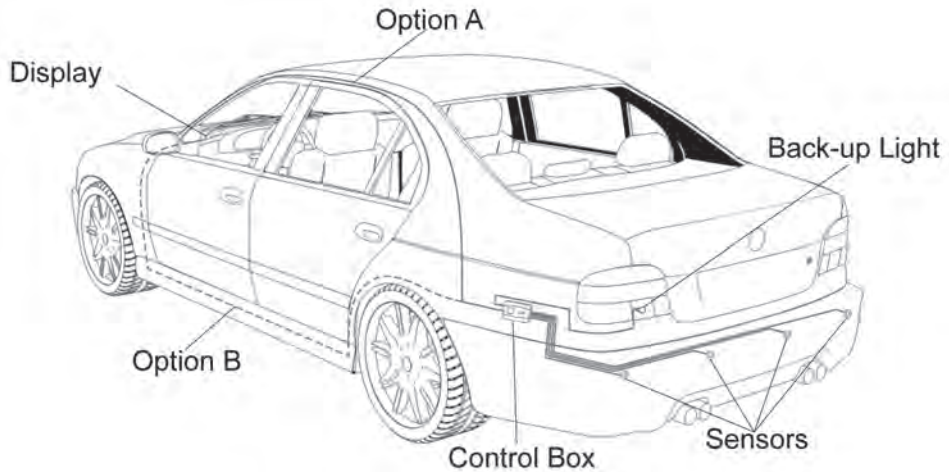

Tools



Sensor Installation



First locate where you are going to install the sensors and place a piece of masking tape.
Measure and mark the positions of the holes.

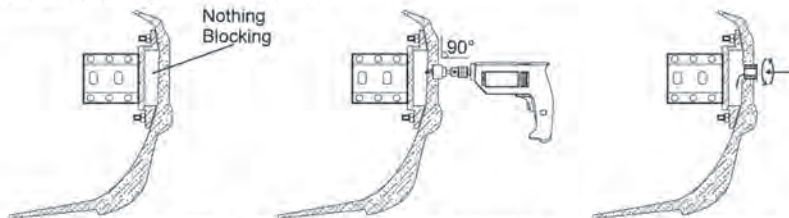

Make sure that there is nothing blocking the area behind the bumper, where the sensors go.

Drilling position must be perpendicular to the surface of the bumper.

As you push, wiggle the sensor and make sure it goes all the way in and flush against the bumper, leaving no gap.

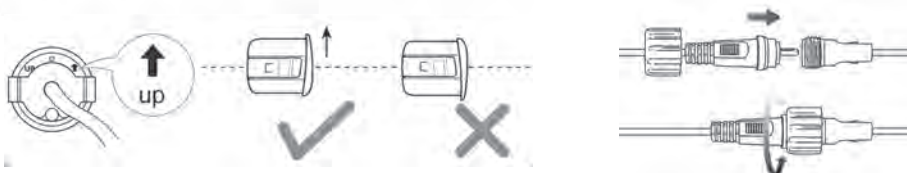

Install the sensors vertically; the "UP" sign must be on upside.

Insert the plug into the socket and wind the turn cap tightly: (Model# HRA-5300)

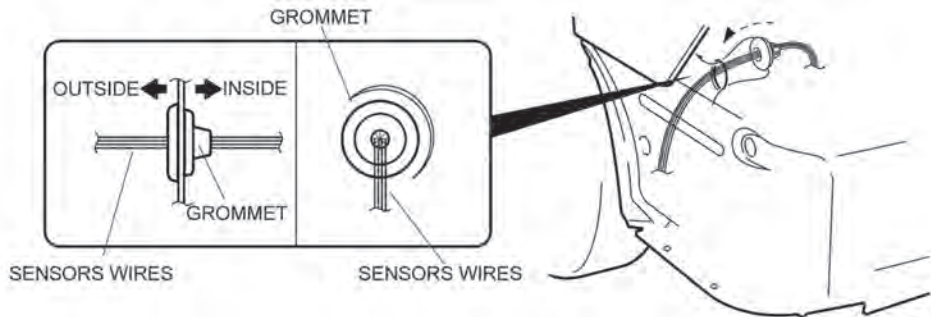

To route the sensor cables, locate a hole/grommet or if possible route through tail lights slots.

Display Installation

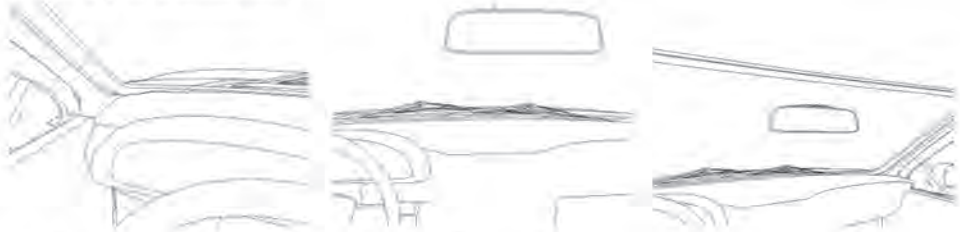

Select an area to mount display firmly and easy for the driver to see.
Clean surface with alcohol and use the double sided tape to mount.

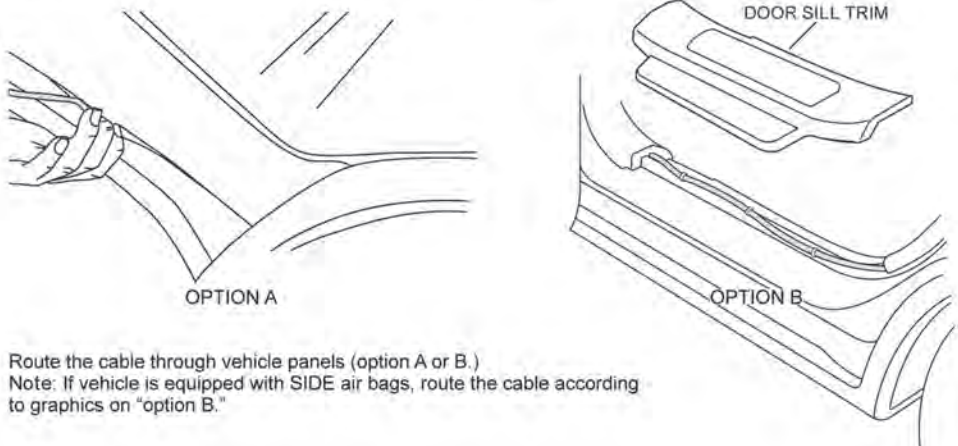

Route the cable through vehicle panels (option A or B.)
Note: If vehicle is equipped with SIDE air bags, route the cable according to graphics on "option B."

Control Box Installation

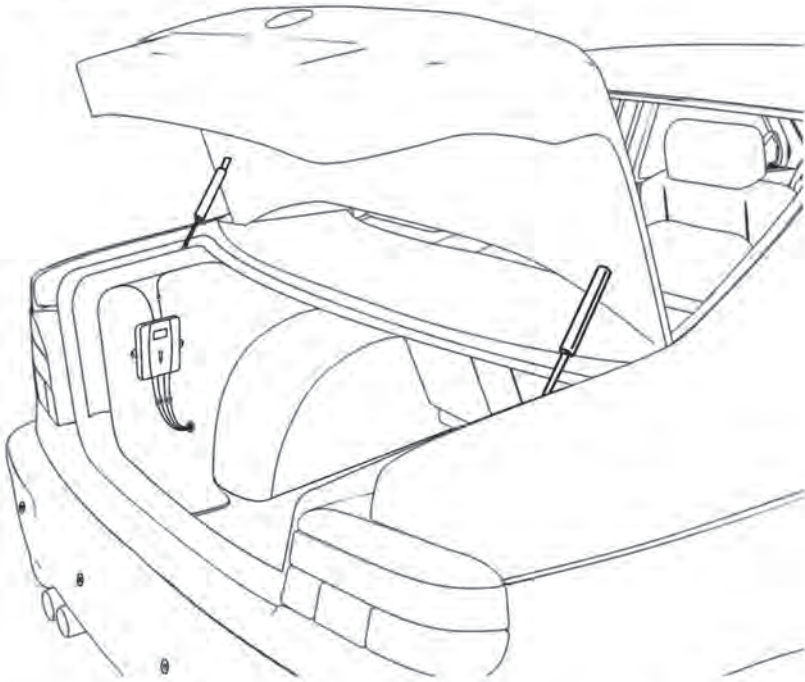

Remove the necessary back panels to mount the control box in a safe place, away from rain, heat or humidity.

Wiring Installation for 4 Sensor Kit

- Connect the Red wire of the control unit to the (+) positive wire of the vehicle reverse indicating light.
- Connect the Black wire (-) to the vehicle's chassis or negative of battery.

Wiring Installation for 6 & 8 Sensor Kit

- Connect the Red wire of the control unit to the (+) positive wire of ignition wire (ACC 12v).
- Connect the Black wire (-) to the vehicle's chassis or negative of battery.
- Connect White wire to the (+) positive wire of the vehicle reverse indicating light.
- Connect Grey wire to the (+) positive wire of the vehicle foot brake light.

4 Sensor Installation

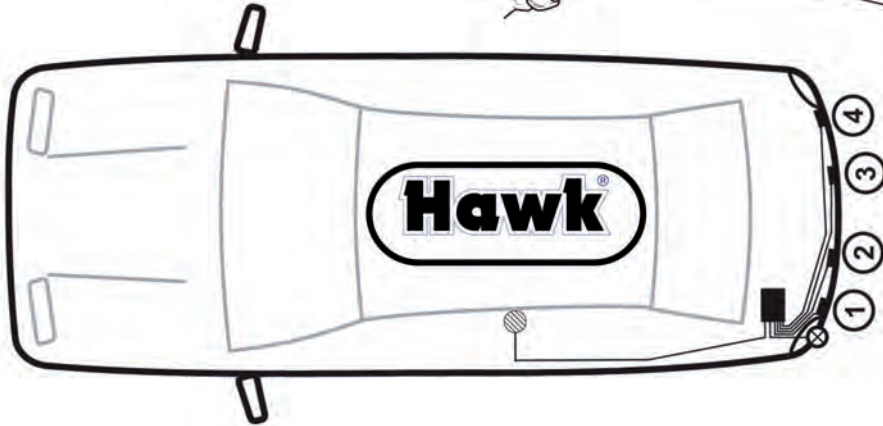
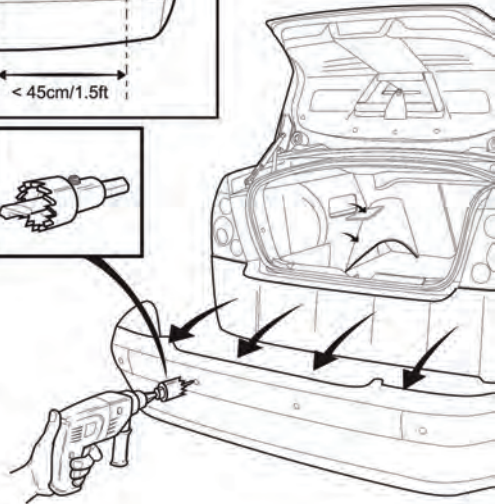
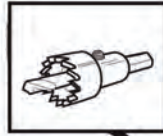
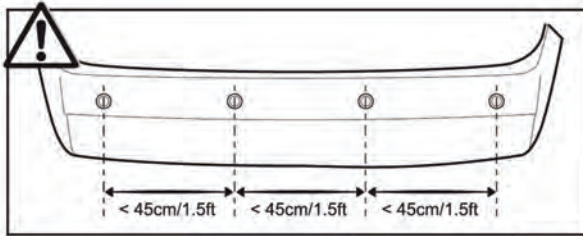

6 Sensor Installation

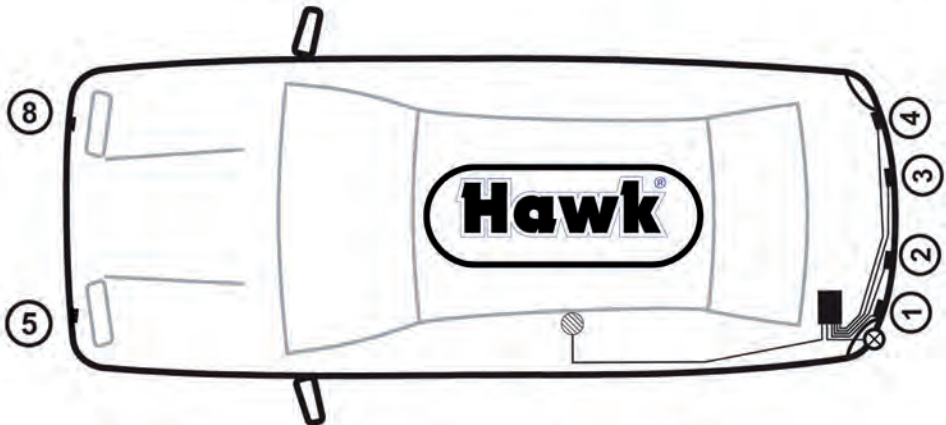
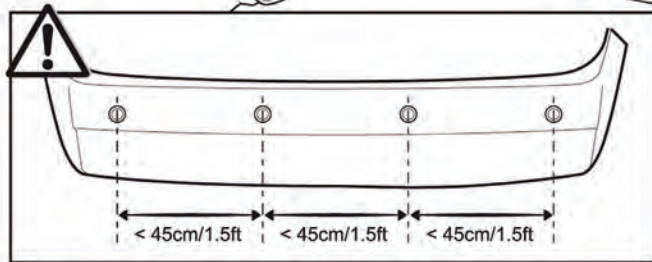
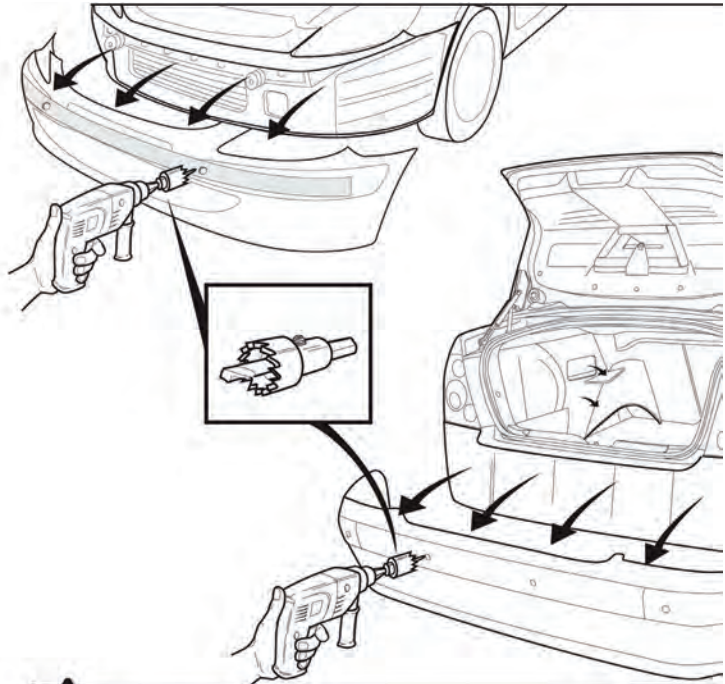

8 Sensor Installation

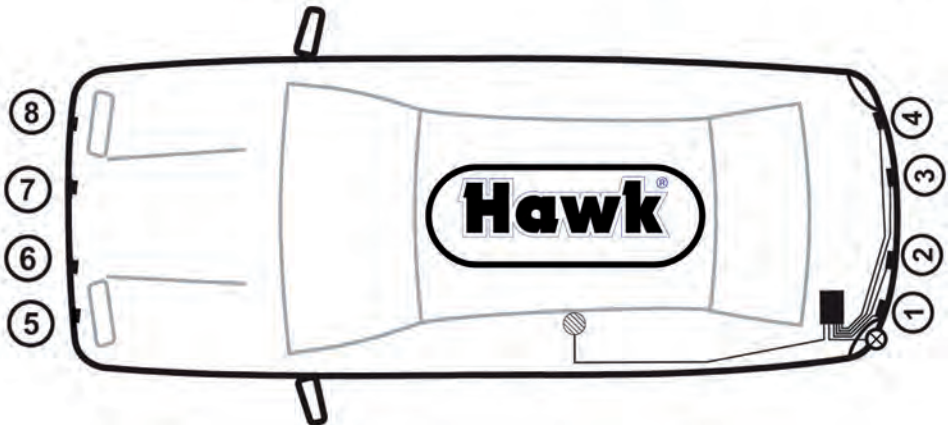
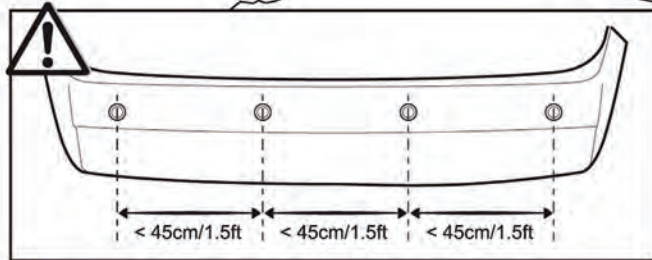
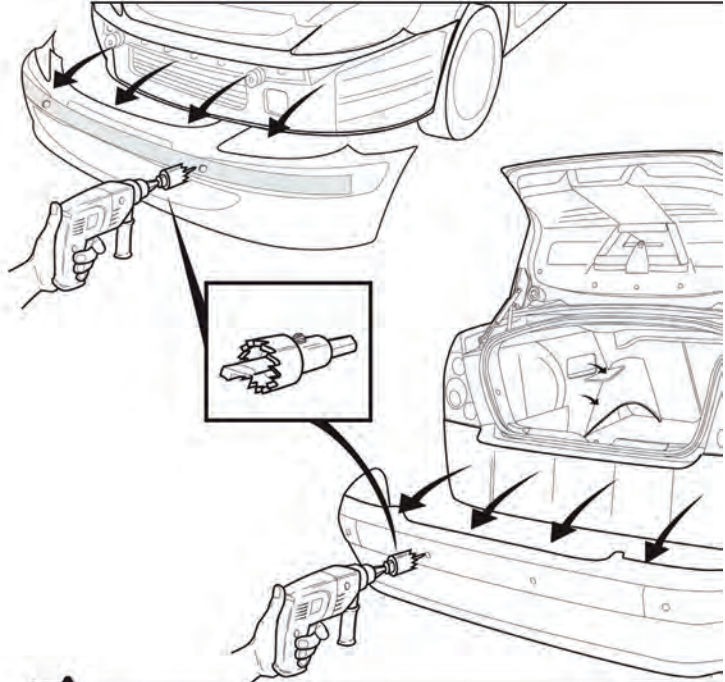

After Installation Test

Use the following to test and verify the operation of the backup system.



Warning: Do not stand behind a moving vehicle death or injury could occur. Prior to testing, set the parking brake On, ignition key On (do not start), step foot on brake and shift the vehicle into reverse. Ensure that the engine is not running while proceeding with the following tests.

Test the system operation with a piece of wood (8 inches wide x 3 feet, 3 inches high) after the installation. Start with the wood more than 8.4 feet away from the vehicle. Then move the wood closer to the vehicle and ensure that the buzzer, LED, and distance indicators display correctly.

Trouble shooting

No buzzer or display at power up?

1. Is power wire connected to ECU correctly?
2. Verify (+) 12v at ECU when vehicle is in reverse.
3. Verify the ground connection.
4. Have you connected to the correct reversing indicator wire?
5. Do you have a minimum of (+) 12V and ground at the display?

False warning tone or false LED flashing

1. Is the sensor mounted too low or pointing to the ground?

Sensors do not detect any objects?

1. Is the vehicle's exhaust smoking? Correct or allow it to clear before proceeding with testing.
2. Are sensors properly plugged into the correct sockets?

CONSUMER WARRANTY

Commercial Electronics ("HAWK") promises to the original purchaser to repair or replace with a comparable reconditioned model any HAWK unit (hereafter the "unit"), excluding without limitation the siren, the remote transmitters, the associated sensors and accessories, which proves to be defective in workmanship or material under reasonable use during one year from date of purchase. provided the following conditions are met: the unit was professionally installed and serviced by an authorized HAWK dealer; the unit will be professionally reinstalled in the vehicle in which it was originally installed by an authorized HAWK dealer; and the unit is returned to HAWK, shipping prepaid with a legible copy of the bill of sale or other dated proof of purchase bearing the following information: consumer's name, telephone number and address; the authorized dealers name, telephone number and address; complete product description, including accessories; the year, make and model of the vehicle; vehicle license number and vehicle identification number. All components other than the unit, including without limitation the siren, the remote transmitters and the associated sensors and accessories, carry a one-year warranty from the date of purchase of the same. This warranty is non-transferable altered, the unit has been modified or used in a manner contrary to its intended purpose; the unit has been damaged by accident, unreasonable use, neglect, improper service, installation or other causes not arising out of defects in materials or construction. The warranty does not cover damage to the unit caused by installation or removal of the unit. HAWK, in its sole discretion, will determine what constitutes excessive damage and may refuse the return of any unit with excessive damage. **TO THE MAXIMUM EXTENT ALLOWED BY LAW, ALL WARRANTIES, INCLUDING BUT NOT LIMITED TO EXPRESS WARRANTY, IMPLIED WARRANTY, WARRANTY OF MERCHANTABILITY, FITNESS FOR PARTICULAR PURPOSE AND WARRANTY OF NON-INFRINGEMENT OF INTELLECTUAL PROPERTY, ARE EXPRESSLY EXCLUDED; AND HAWK NEITHER ASSUMES NOR AUTHORIZES ANY PERSON OR ENTITY TO ASSUME FOR IT ANY DUTY, OBLIGATION OR LIABILITY IN CONNECTION WITH ITS PRODUCTS. HAWK DISCLAIMS AND HAS ABSOLUTELY NO LIABILITY FOR ANY AND ALL ACTS OF THIRD PARTIES INCLUDING ITS AUTHORIZED DEALERS OR INSTALLERS. HAWK SECURITY SYSTEMS, INCLUDING THIS UNIT, ARE DETERRENTS AGAINST POSSIBLE THEFT. HAWK IS NOT OFFERING A GUARANTEE OR INSURANCE AGAINST VANDALISM, DAMAGE OR THEFT OF THE AUTOMOBILE, ITS PARTS OR CONTENTS; AND HEREBY EXPRESSLY DISCLAIMS ANY LIABILITY WHATSOEVER, INCLUDING WITHOUT LIMITATION, LIABILITY FOR THEFT, DAMAGE AND/OR VANDALISM. THIS WARRANTY DOES NOT COVER LABOUR COSTS FOR MAINTENANCE, REMOVAL OR REINSTALLATION OF THE UNIT OR ANY CONSEQUENTIAL DAMAGES OF ANY KIND. IN THE EVENT OF A CLAIM OR A DISPUTE INVOLVING HAWK OR ITS SUBSIDIARY, THE PROPER VENUE SHALL BE ENGLAND & WALES . THE MAXIMUM RECOVERY UNDER ANY CLAIM AGAINST HAWK SHALL BE STRICTLY LIMITED TO THE AUTHORIZED HAWK DEALER'S PURCHASE PRICE OF THE UNIT. HAWK SHALL NOT BE RESPONSIBLE FOR ANY DAMAGES WHATSOEVER, INCLUDING BUT NOT LIMITED TO, ANY CONSEQUENTIAL DAMAGES, INCIDENTAL DAMAGES, DAMAGES FOR THE LOSS OF TIME, LOSS OF EARNINGS, COMMERCIAL LOSS, LOSS OF ECONOMIC OPPORTUNITY AND THE LIKE. NOT WITH STANDING THE ABOVE, THE MANUFACTURER DOES OFFER A LIMITED ONE YEAR WARRANTY TO REPLACE OR REPAIR THE CONTROL MODULE AS DESCRIBED ABOVE.**

