



X50_{v3}

Installation Manual

Guide to Intelligent Alarm Immobiliser



Manufacturer:
COMMERCIAL ELECTRONICS
264 HAYDONS ROAD, WIMBLEDON, LONDON SW19 8TT. UK

TEL: +44 020 8404 7105 FAX: +44 020 84047104
<http://www.hawkcaralarm.com> e-mail: info@hawkcaralarm.com

Installing HAWK® Motorcycle Alarm System (General Guidance)

We think you've made an excellent choice in allowing HAWK® to protect your bike. Now the question is: "How in the world am I going to install this – there are so many wires." What seems like a hard task is actually not too bad; however, you need to have at least some mechanical ability. Installation is all about planning, gathering information, and careful execution. Yes, you will need to do a little research to make your installation easier. The more information and reference diagrams, the better. You will need to learn how to test the polarity of a wire using a digital multi-meter; see separate section how to use digital multi-meter. Lastly, you will need your basic tools to remove some vehicle panels to access the vehicle wiring.

Gathering Information and Reference Material

Information is the backbone of your soon to be successful installation. You should gather documents with vehicle specific wiring colours, locations and polarities.

Planning the Alarm Install

Your plan will be the difference between a finished product and a job left for next winter. A few minutes of planning and prepping will yield at least an hour and a half less install time. It's not fun, but it needs to be done! Begin by studying your vehicle specific diagram side by side with your bike alarm installation diagram. Identify which features you plan to use on the alarm, not all features are necessary. (e.g., remote starting)

Preparing the Wiring

Once you identify which items you will install along with the alarm, eliminate the unused wires to prevent clutter. It is common practice to twist the wires of a same plug together then secure them to each other with electrical tape. Do not wrap the entire bundle, as different wires go to different locations. Once you finish wrapping all the harnesses tape them to each other to create one large pigtail containing all of the used wires. This keeps the wires together, secure and free from frays and obstruction. You will now want to identify the locations of the wires which you will connect to on your bike. Take your harness of wires on the alarm which you just organized together, and split it down once more into vehicle locations. Group wires into three different groupings, for example dash, rear, and engine wires, or use your own grouping procedure. Tape these wires together in their bundles to create individual wiring bundles.

Checking the Bike

You will need to inspect your vehicle to be sure of a few things previous to beginning the installation process. Check your vehicle and identify which tools are needed to remove the necessary panels. You will once again refer to your vehicle wiring diagram to find the locations of the wires where the panels will be removed. Once done, you are ready to begin the installation.

It's virtually impossible to install a motorcycle alarm system without a multi-meter; therefore, if you plan to do the install, this is a must have. You can purchase a digital multi-meter for about £4.99 from Electronic Hardware store e.g. Maplin. (See below for detailed instructions on using a multi-meter).

Using a Multi-meter and Testing Wires

A digital multi-meter is your safeguard when doing a motorcycle alarm. Testing wires before you make a connection is a sure fire way to make sure you are making a proper connection. Your multi-meter should have a DC setting with 2 leads, red and black: positive (+) and negative (-).

Testing Wires

When installing any electrical component into a vehicle, you will have 3 polarities which you may need to test for. There are positive, negative and reverse polarity configurations which you must know how to test for.

Positive (+)

When testing for a wire which should have a positive polarity, you will need to do as follows. Set your multi-meter to 12Volts DC. Connect your black lead to chassis ground (-). Next connect your red lead to the wire which you believe has 12volts. The meter will show 12V if that wire is positive. The meter will show 0 if it is not.

Negative (-)

When testing for a wire which should be negative (grounded), you will need to do as follows. Connect the red lead from your meter to 12volts constant (+). Connect the black lead to the wire you believe is grounded. The meter should show 12V if that wire is grounded. It will show 0 if it is not.

Specific Testing Applications

Ignition Wires

12Volts with key in all positions except for 'off'

Testing an ignition wire is simple. Ignition wires are generally positive in polarity. Start by setting your meter to DC 12V. Next, take your black lead and put it to chassis ground (-). Next, connect the red lead to what you believe to be the ignition wire in the vehicle. It should show 0 Volts when the key is off. Next, cycle the key through the Accessory and Ignition position. It should show 12Volts in both positions. Next, crank and run the vehicle. It should show power even while cranking. If it does, it is an ignition wire. If not, please read "testing an accessory wire" below. Ignition Wires are used for motorcycles alarm and remote Starting.

Accessory Wires 12Volts with key in all positions except off and crank

Testing an accessory wire is the same as testing an accessory wire. The only exception is the meter should show 12volts with the key in the accessory and ignition positions only. There should be 0 volts in the off and crank position. Accessory wires are used in remote starting Installations, and are especially important on bikes with EFI.

Starter Wires 12volts ONLY in crank position

Testing a starter wire is very simple. Start by locating the suspected wire in the vehicle. Next, take your meters black lead and connect it to ground. Next, connect the red lead to the wire you believe

is the starter wire. Crank the vehicle. The meter should ONLY show 12V when the key is in the crank position. There should be 0 volts in all other positions. Starter Wires are used in Remote Car Starter Installations.

Using the above testing guidelines, you can test any wire. When testing an accessory like a horn or dome light in the vehicle, simply activate the accessory with your meter leads in place to get the meter reading. The meter should only read power and ground on accessory items when they are activated.

Install Your HAWK compact Motorcycle Alarm System

PLANNING THE INSTALLATION

The Box Contains	Tools Required:
<ul style="list-style-type: none"> · The Control Unit · Two Remote Transmitters · Installation Instruction · User Guide · Siren · Wiring Loom · Warranty Information · Alarm Warning Sticker · Neck Strap 	<ul style="list-style-type: none"> · Pliers/Cable Cutters · Motorcycle wiring diagram · Drill (9.5mm & 8mm bits) · Soldering Equipment · Self Adhesive Heat sink Tubing · Good quality insulating tape · Masking Tape · Multi-meter · General Workshop Tools

LOCATION OF MAIN SYSTEM COMPONENTS

Before commencing with the installation, plan where to secure the main components. See the location diagram for suggested locations for the main components of the system.

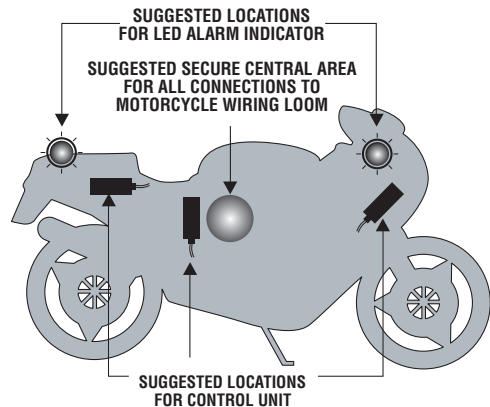

MOUNTING CONTROL UNIT

The control Unit should be located in a protected environment with good access to the motorcycle wiring loom. Avoid extremes of heat i.e. exhaust engine and direct exposure to the elements, and make sure that the unit does not interfere with normal operation of the motor cycle. Suggested locations under the seat or behind the seat are usually the best locations. The control wiring must point down to avoid any water ingress.

MOUNTING THE SIREN

Ensure that the siren is not installed in a position prone to excessive heat, water or mud splashes! The siren should be facing slightly down so that water will not pool. Fasten the Siren in place using double sided tape provided with the alarm. Prior to applying the double sided tape, clean the affected surfaces with a suitable cleanser that will remove any dirt and grease. The siren plugs directly into its mating connector of the alarm harness for easy installation.

LED ALARM INDICATOR

The desired location of the LED Alarm Indicator should be mounted in a prominent position; suggested locations are the instrument cluster or a rear body panel with good viewing access.

INSTALLATION OF MAIN SYSTEM COMPONENTS

Great care has been taken in the design and manufacture of HAWK products, Correct installation and good working practices will enhance the operation of the alarm system and give long term benefit to the user.

1. position and attach the Control unit
2. position and attach the LED Alarm indicator

ALARM WIRING

Plan where to make the connections to the motorcycle wiring loom. The alarm loom should run alongside the original motorcycle loom taking full advantage of the motorcycle wiring loom integrity. Normally all connections can be made to a central area on the motorcycle loom, such as under the petrol tank.

NOTE: Soldered joints are recommended for all wiring connections.

Common wiring diagram of various bikes (guidance only).

Cables of HA-X50	Function	HONDA	SUZUKI	YAMAHA
Red	Positive	Red	Red	Red
Green x 2	Negative	Green	Black/White	Black
Orange	Indicator	Orange	Dark Green	Dark Green
Light Blue	Indicator	Light Blue	Black	Dark Brown
Black/Red	Ignition positive	Black	Orange	Brown
Grey	Immobiliser			
White/Black	Immobiliser			
Black/White	Immobiliser			
Yellow/Red	Remote Start	Yellow/Red	Yellow/Green	Blue/White

ALARM WIRING INSTALLATION

IMPORTANT

Make sure that you have planned the wiring connections before adapting / cutting the alarm loom or the motorcycle loom.

1. Connect RED wire to constant power input (+) 12v supply from the battery.
2. Connect BLACK/RED wire to any wire in the ignition system which becomes live when the ignition is switched ON, and remains live when the starter is pressed e.g. power feed from ignition switch to fuse box.
3. Connect ORANGE wire to left indicator positive (+) lead output. **Take care not to use the motorcycle indicator negative (-) wire.**
4. Connect LIGHT BLUE wire to right indicator positive (+) output. **Take care not to use the motorcycle indicator negative (-) wire.**
5. Connect YELLOW/RED wire to the remote starter (+) switch.
6. Engine immobilisation- there is 3 cables 1) BLACK/WHITE wire 2) WHITE/BLACK wire 3) Grey. **Please see pages 12-15 for installation.** Recommended circuits are the starter motor or fuel pump relay. (The CPU on Italian motorcycles or the Hall Effect ignition on Harley Davidsons is not recommended.)
7. Connect 2 x GREEN earth wires to the motorcycle frame or the battery negative terminal.
8. Connect small 2 pin connector to LED
9. Blue/White wire for optional negative input sensor e.g. tilt or microwave sensor
10. Connect large 2 pin connector to Siren

▲ **ATTENTION:** Commercial Electronics always suggests installation be performed by a certified and trained installation technician, professional installation is requirement to obtain full warranty. This wiring information is being provided free of charge and on an “as is” basis, without any representation or warranty to the products being installed. It is your responsibility to insure proper installation. Commercial Electronics assumes no responsibility with regards to the accuracy or currency of this information. Proper installation in every case is and remains the responsibility of the installer. Commercial Electronics assumes no responsibility resulting from an improper installation, even in reliance upon this information. Any harm or injury to the installer is in no way the responsibility of Commercial Electronics. Any damage to the vehicle during installation or after installation is not the responsibility of Commercial Electronics.

POWER ⊕ AND ⊖ WIRES

STEP 1

Connecting the Red & Green wires

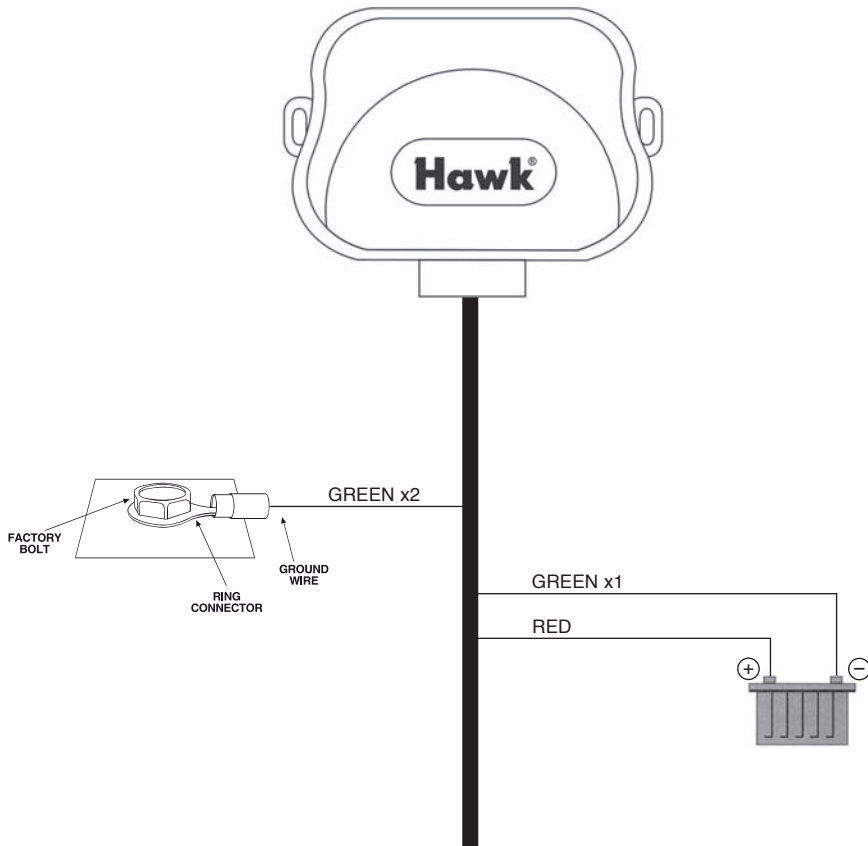

Important: Remove fuse from alarm wire harness (Red wire)

1. Connect RED wire to the positive (+) of battery terminal
2. Connect GREEN (1) wire to the negative (-) of battery terminal.
3. Connect GREEN (2) wire to chassis ground connection, connect this wire to bare metal of the vehicle.

INDICATOR WIRES

STEP 2

Connecting the Orange & Light Blue wires

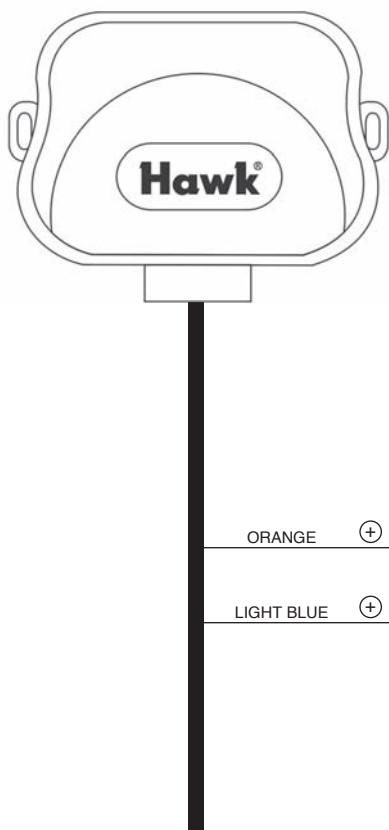

Bike	Left Indicator	Right Indicator
Honda	Orange wire	Light Blue wire
Kawasaki	Green wire	Grey wire
Suzuki	Green or Black	Grey wire
Yamaha	Green wire	Brown wire
Harley Davidson	Brown wire	Purple wire

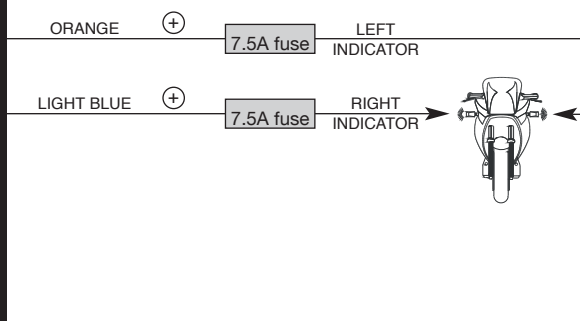

1. Locate the left and right indicator wires at the rear of bike are usually easiest to wire up.
 2. Connect orange wire to the left positive (+) indicator feed.
 3. Connect light blue wire right positive (+) indicator feed.
- Take care not to use the motorcycle indicator negative (-) wire.**

IGNITION SWITCH WIRES

STEP 3

Connecting the Black wire

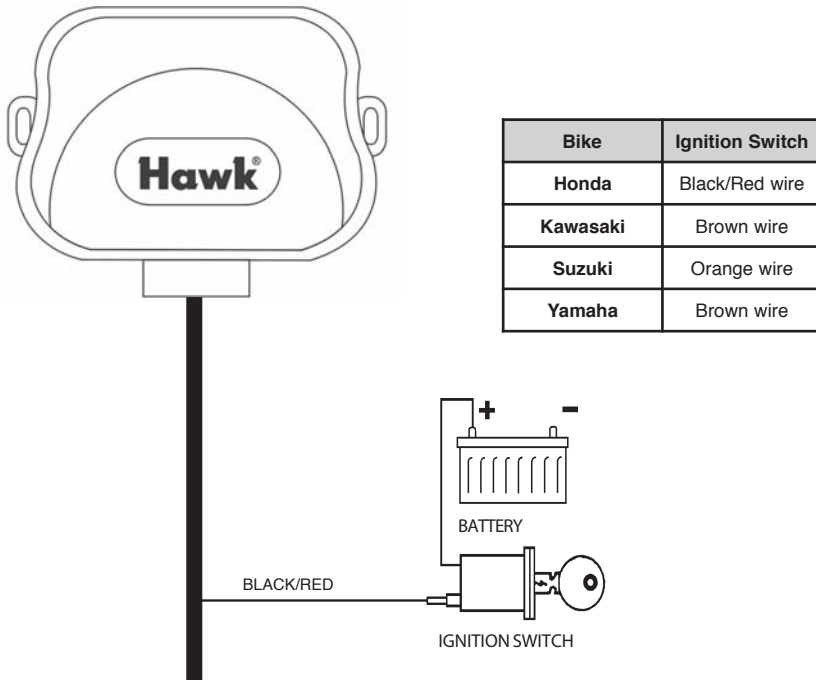

This wire must be connected to wire that gives positive (+) 12 volt when the ignition key is turned on and this wire should not show any voltage when ignition turned off.

NOTE: However there may be more than one wire, make sure you have the correct ignition feed.

NOTE: This wire can be located at the main ignition switch below.

Now:

1. Connect siren to alarm system
2. Connect LED to alarm system
3. Put fuse into alarm fuse holder (RED wire)

At this point test the alarm and make sure it is working.

For advance features i.e. immobiliser or remote start, see pages 12-16.

BASIC ALARM INSTALLATION

Model: X50

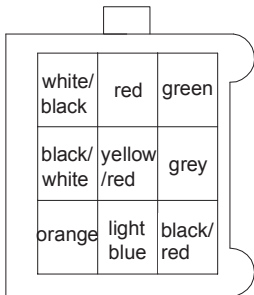

Rear view of wiring loom

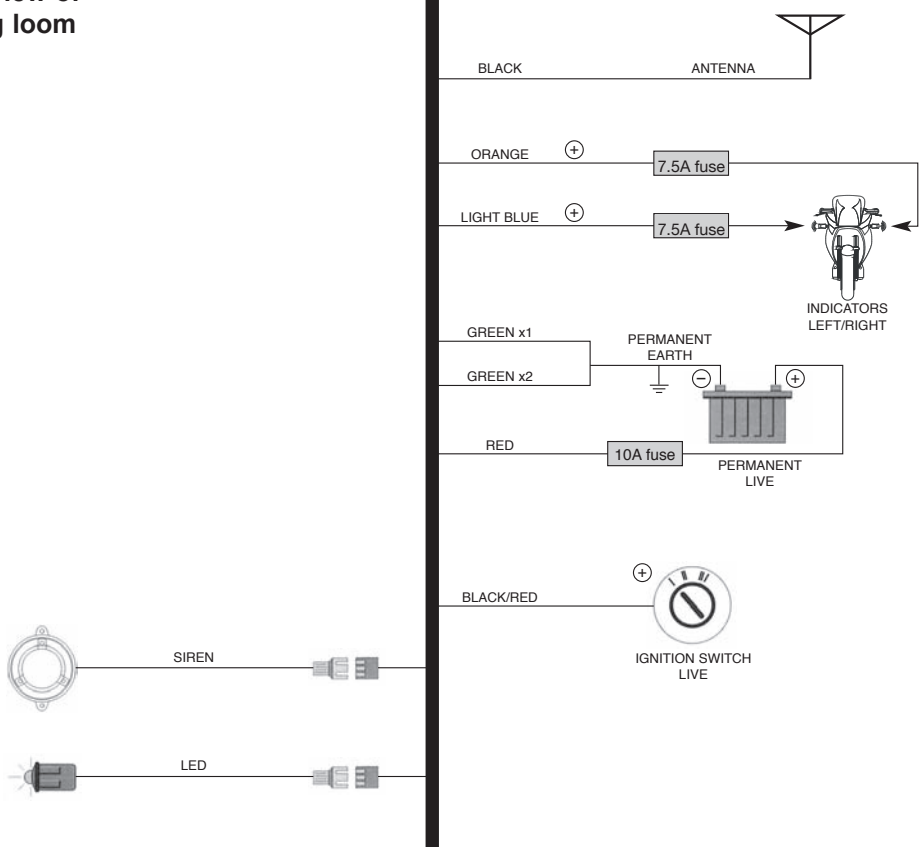

FULL ALARM INSTALLATION

Model: X50

white/black	red	green
black/white	yellow/red	grey
orange	light blue	black/red



Rear view of wiring loom

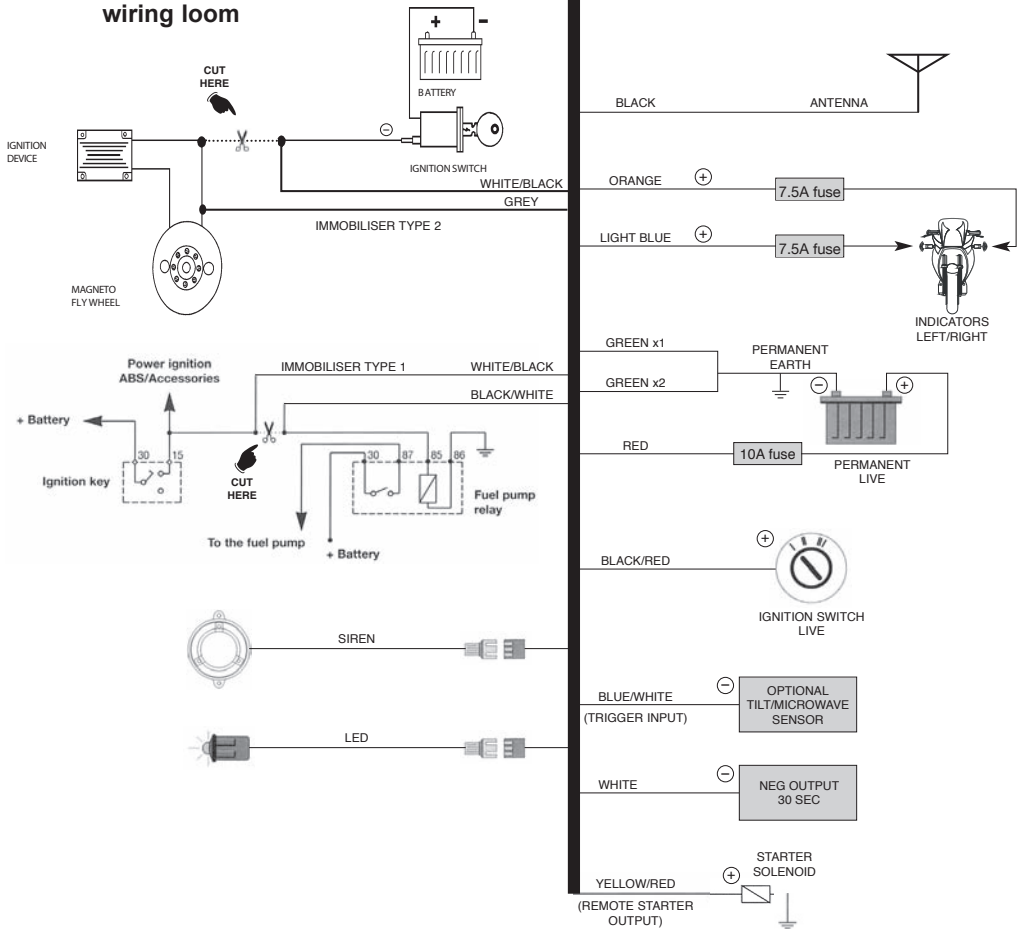

ENGINE IMMOBILISATION CONNECTING DIAGRAM

Connecting the White/Black & Black/White wires

Most large motorcycles with four-stroke engines use this system.

Fig. 1a

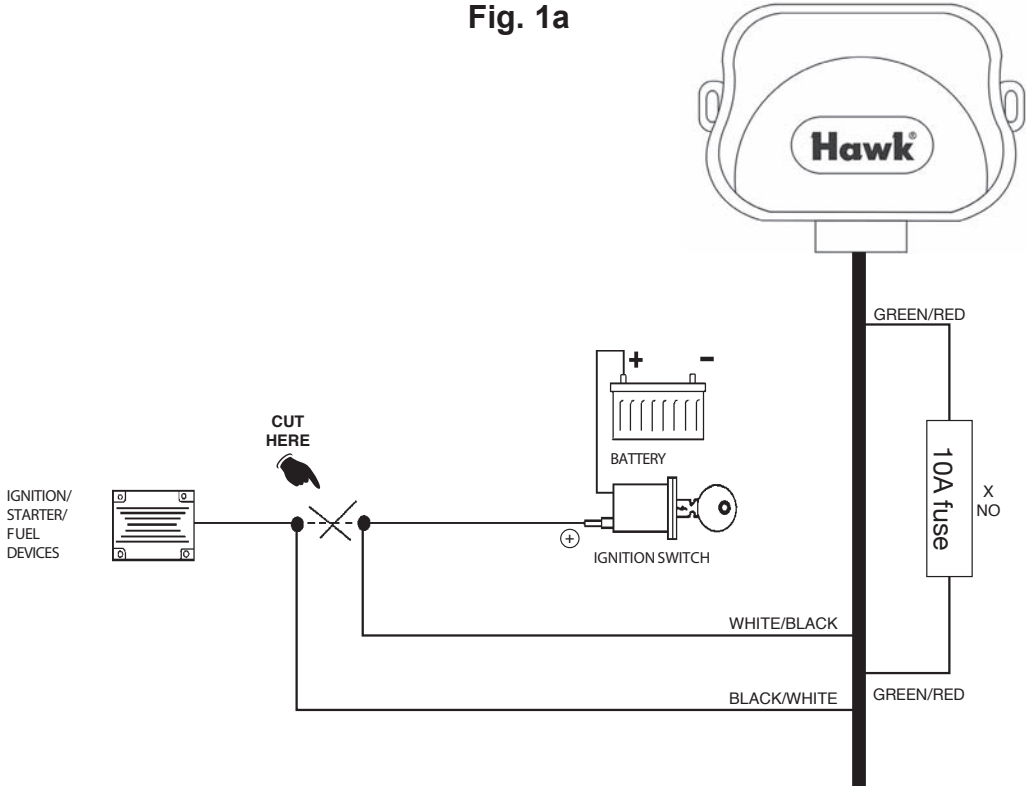

IGNITION SWITCH METHOD

Locate the positive (+) feed wire, cut feed wire then connect one end to **WHITE/BLACK** wire and connect other end to **BLACK/WHITE** wire. See diagram Fig. 1a.

IMPORTANT: Do not insert any fuse in to the white fuse holder.

ENGINE IMMOBILISATION CONNECTING DIAGRAM

Connecting the White/Black & Black/White wires

Most large motorcycles with four-stroke engines use this system.

Fig. 1b

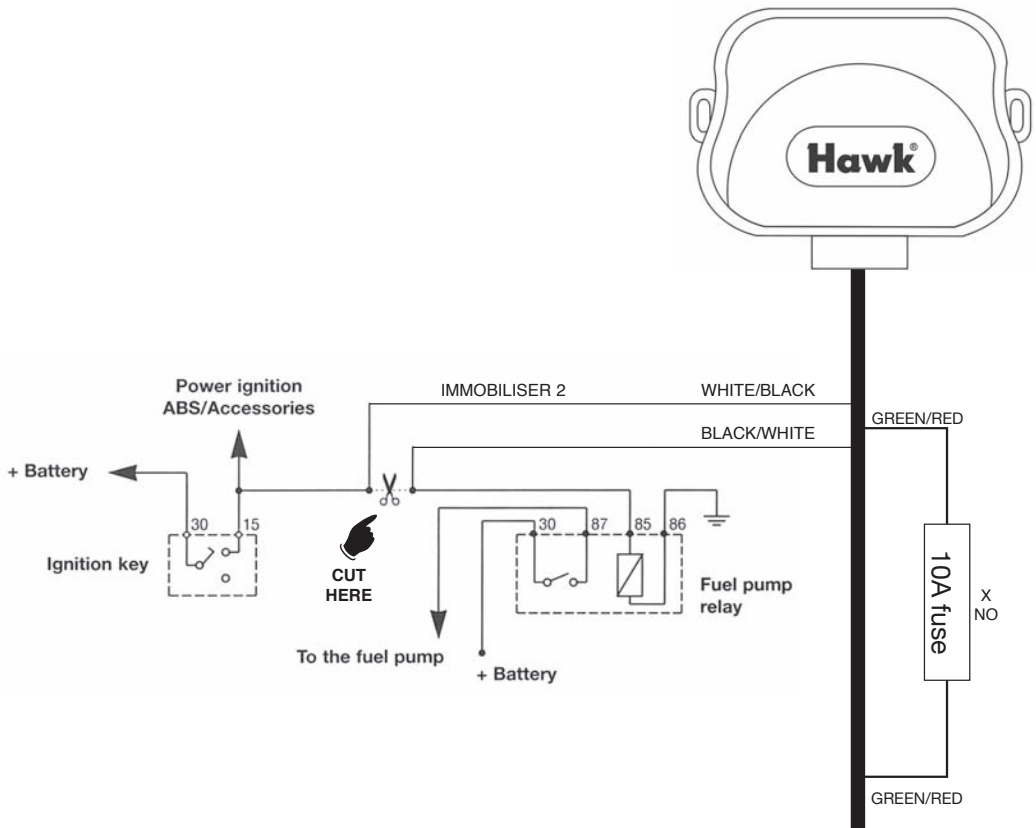

FUEL PUMP METHOD

Locate the positive (+) feed wire of fuel pump, cut feed wire then connect one end to **WHITE/BLACK** wire and connect other end to **BLACK/WHITE** wire. See diagram Fig. 1b.

IMPORTANT: Do not insert any fuse in to the white fuse holder.

ENGINE IMMOBILISATION CONNECTING DIAGRAM

Connecting the White/Black & Black/White wires

Most large motorcycles with four-stroke engines use this system.

Fig. 1c

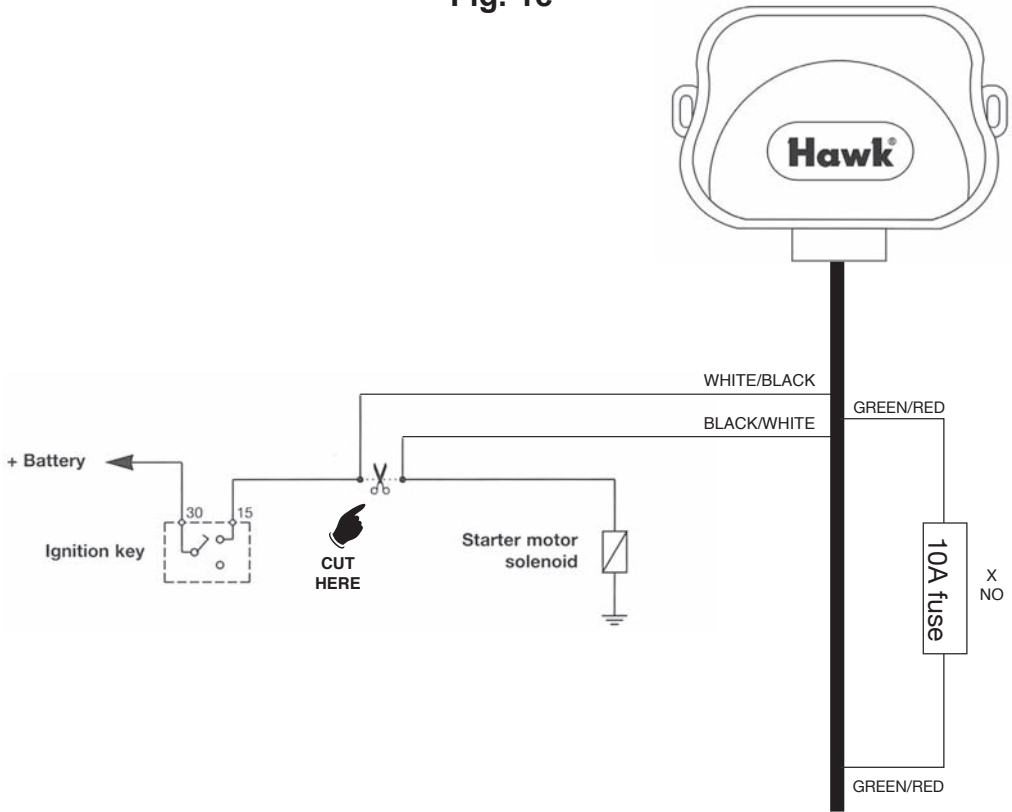

STARTER SWITCH METHOD

Locate the positive (+) feed wire of push start switch, cut feed wire then connect one end to WHITE/BLACK wire and connect other end to BLACK/WHITE wire. See diagram Fig. 1c.

IMPORTANT: Do not insert any fuse in to the white fuse holder.

ENGINE IMMOBILISATION CONNECTING DIAGRAM

Connecting the White/Black & Black/White wires

Most small motorcycles with two-stroke engines use this system, i.e. Scooters/Mopeds.

Fig. 2

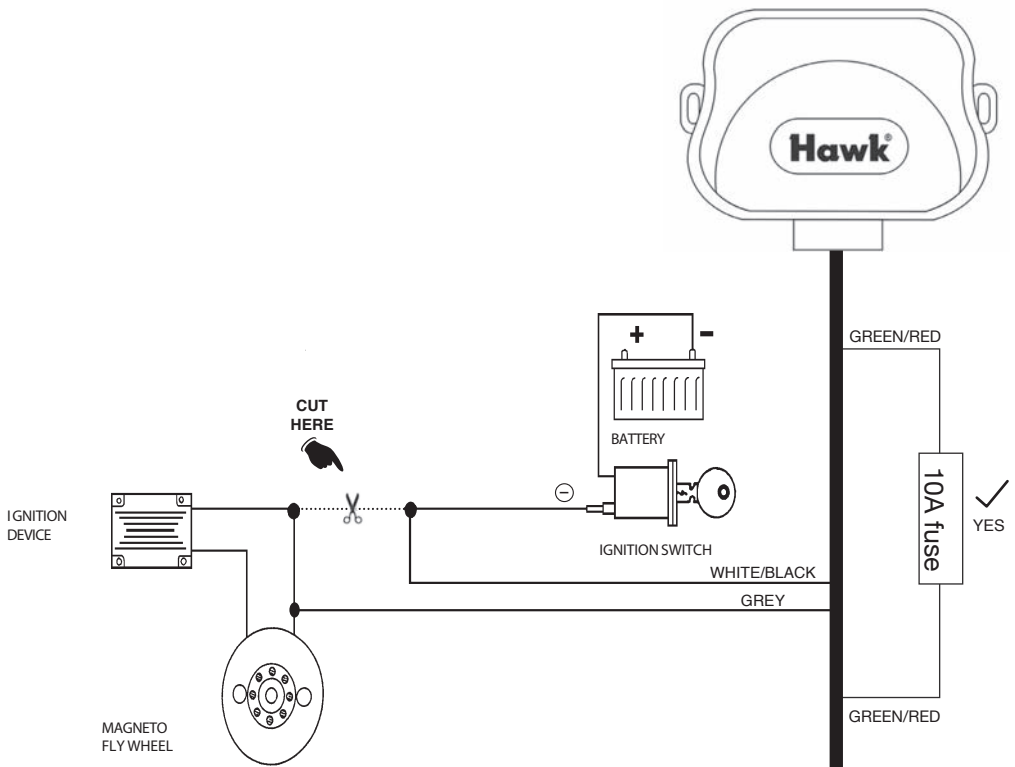

1. At the back of ignition switch locate the ignition disable wire. This wire goes to ground (-) or negative when ignition turned off and is not ground (-) when ignition switch is turned on.
2. Cut the wire and join WHITE/BLACK and GREY wire as shown on Fig 2.
3. Insert 10amp fuse (not supplied) in to the white fuse holder.

REMOTE START WIRE

Connecting the Yellow/Red wire

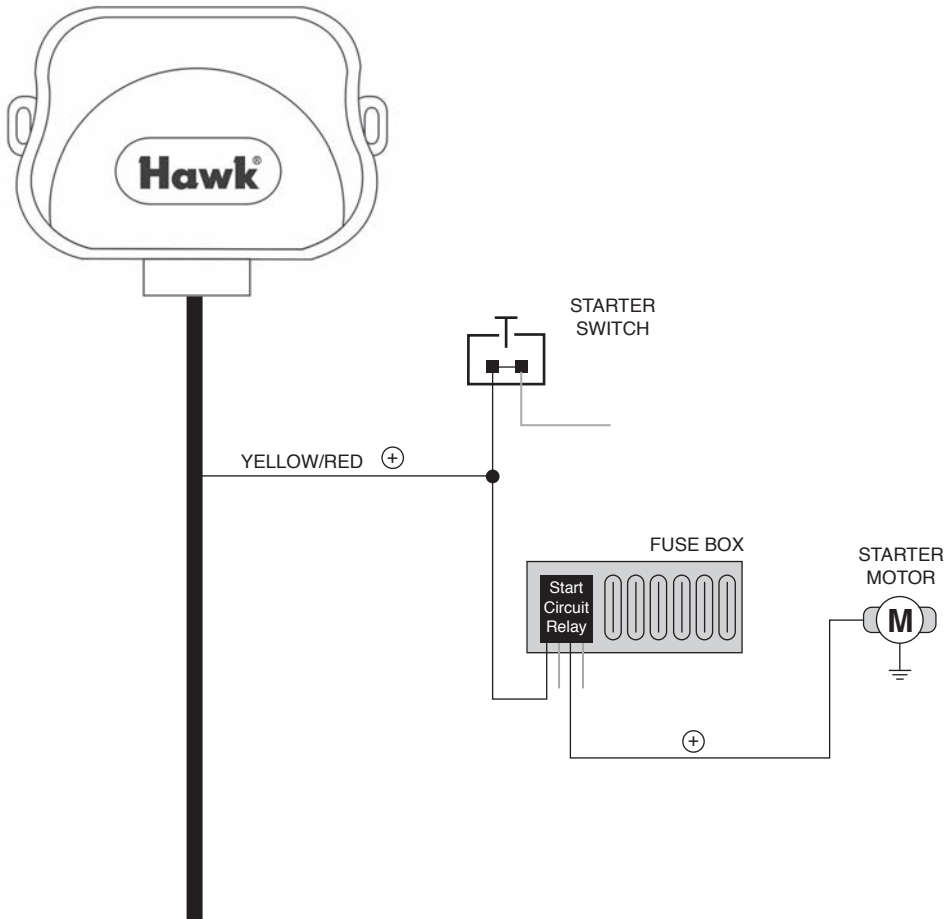

This wire to be connected to output of start switch or start relay.

NOTE: Bike with Positive Starter connect RED wire to RED/WHITE wire (factory default)
Bike with Negative Starter connect GREEN wire to RED/WHITE wire

Most Yamaha Bikes are negative, all other bikes positive (check polarity).

TILT SENSOR (OPTIONALEXTRA)

Connecting the Blue/White wire

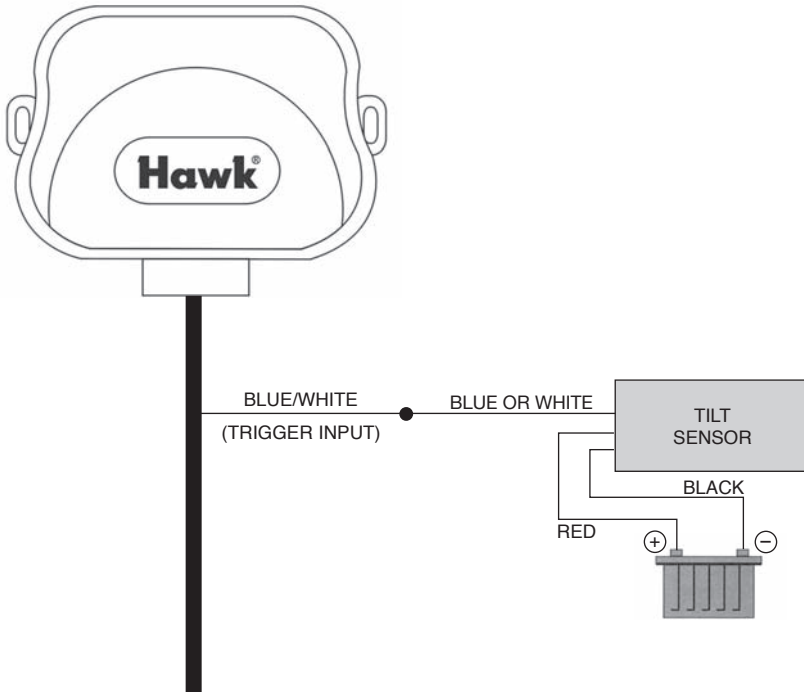

INSTALLATION:

The sensor control module must be mounted at an angle no greater than 45 degrees, with respect to the horizontal plane of the vehicle, and it must be mounted with the case top facing upward. We recommend mounting the control module to the floor of the vehicle. To mount the control module, fasten the unit with the provided double sided tape to secure it in place.

Wiring

RED: Connect to constant positive (+) 12volts

BLACK: (-) Connect to permanent ground negative i.e. negative of battery

BLUE: Connect to instant trigger Aux-negative input of alarm

ADJUSTING:

A corrected adjusting is very important in order to avoid any false alarm. The sensitivity trimmer can be reached through the hole on the top side of the module.

MICROWAVE SENSOR (OPTIONALEXTRA)

Connecting the Blue/White wire

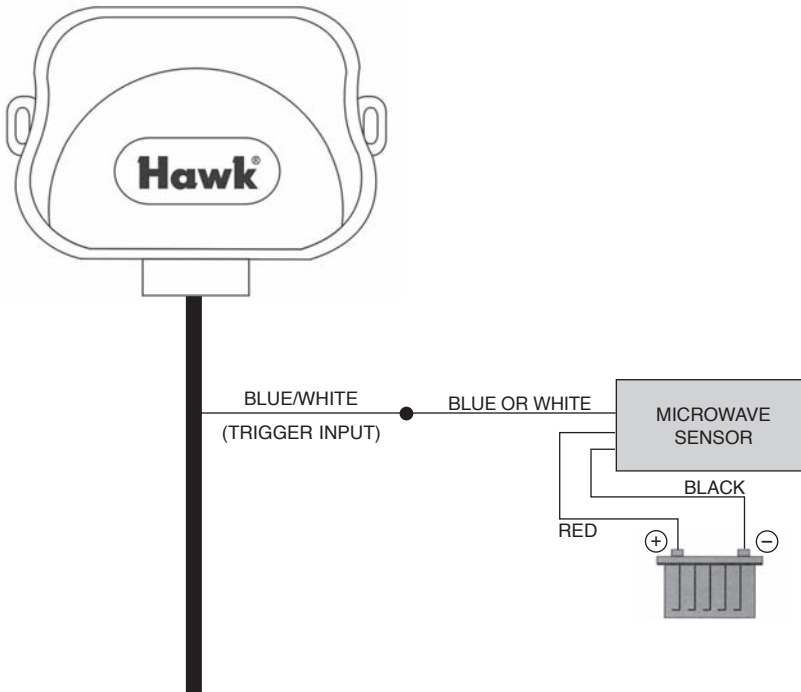

INSTALLATION:

Fit the HA-MW 01 with its backside always pointed on the metal part of the bike. Avoid the presence of any metal objects between the module itself and the area to protect. The high frequency generated by the module, emitted on the front part can easily go through any surface (plastic covers, dashboard, windows, chairs, etc), metal parties excluded.

Wiring

RED: (+) 12volts

BLACK: (-) Connect to ground

BLUE: Connect to instant trigger Aux-negative input of alarm

ADJUSTING:

A corrected adjusting is very important in order to avoid any false alarm. The sensitivity trimmer can be reached through the hole on the bottom side of the module. When testing the sensor, always wait at least 7 seconds delay time, the sensor need this amount of time to re-establish the protective filed

BATTERY BACKUP SIREN (OPTIONAL EXTRA)

Connecting the White wire

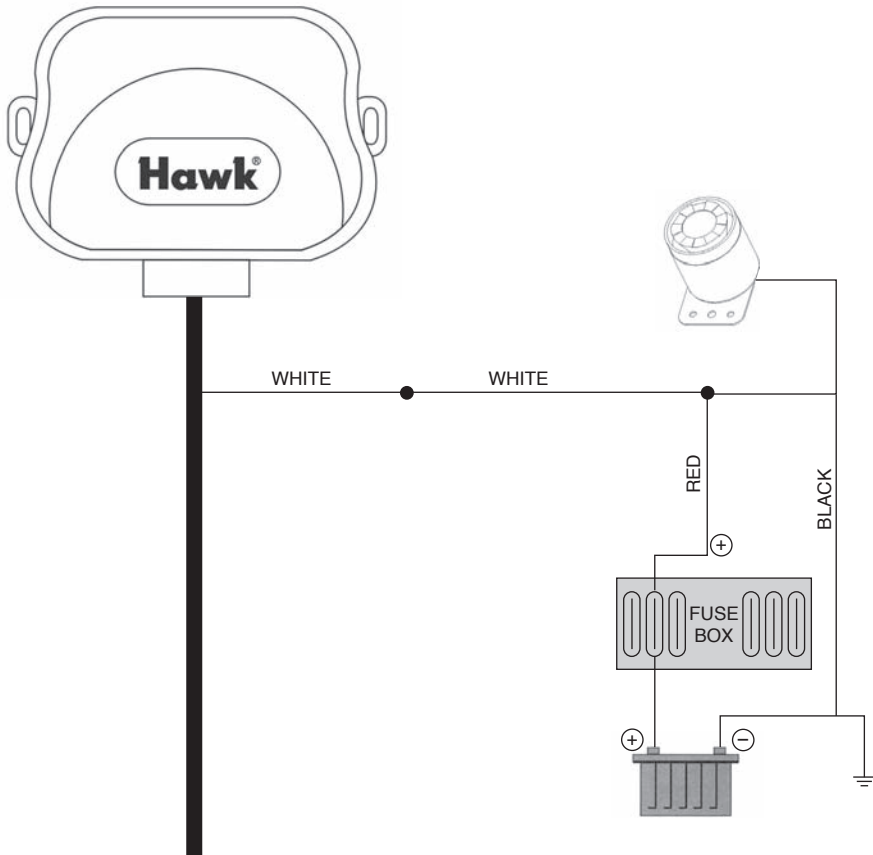

Mounting the Siren

Ensure that the siren is not installed in a position prone to excessive heat, water or mud splashes! The siren should be facing slightly down so that water will not pool. Fasten the Siren in place using double sided tape provided with the alarm. Prior to applying the double sided tape, clean the affected surfaces with a suitable cleanser that will remove any dirt and grease. The siren plugs directly into its mating connector of the alarm harness for easy installation.

Battery Back-up Siren

The Backup Siren has a Piezo-electric element with built-in electronics. The siren will sound if one of the sensors triggers the alarm or if the power supply to the alarm is cut. The back-up function of the siren can be switched off using the enclosed keys. This will be required when disconnecting the motorcycle battery for servicing.

When installation is complete, insert the key and turn to the 'ON' position for normal operation.

CONNECTING THE ALARM WITH SPECIFIC HARNESS

(OPTIONAL EXTRAS)

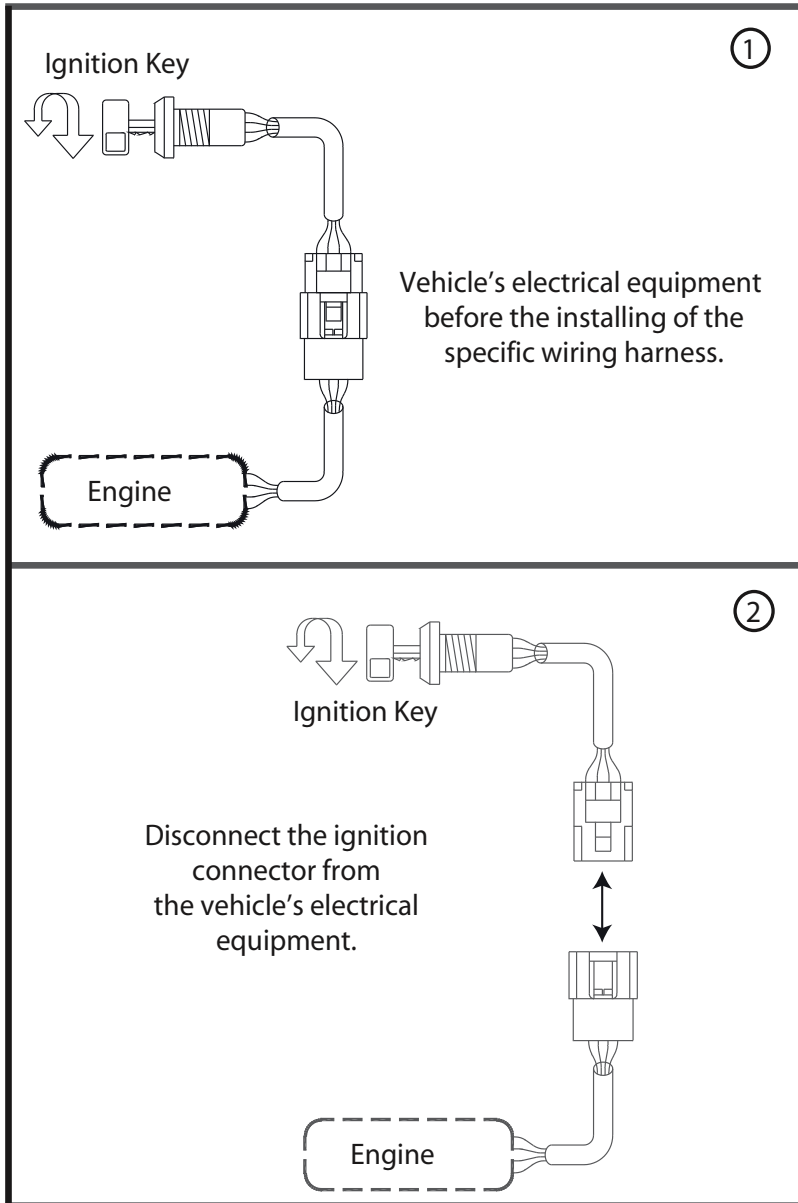

CONNECTING THE ALARM WITH SPECIFIC HARNESS

(OPTIONAL EXTRAS)

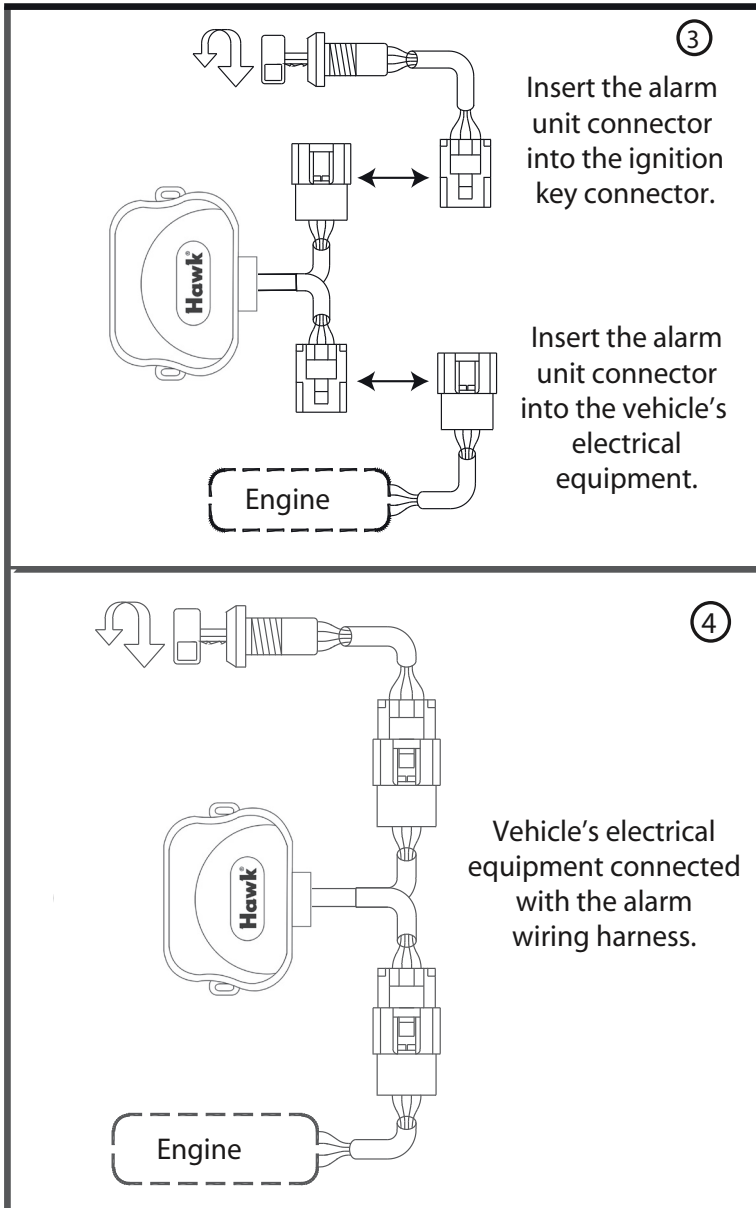

NOTES

Consumer Warranty

Commercial Electronics (“HAWK®”) promises to the original purchaser to repair or replace with a comparable reconditioned model any HAWK unit (hereafter the “unit”), excluding without limitation the siren, the remote transmitters, the associated sensors and accessories, which proves to be defective in workmanship or material under reasonable use during one year from date of purchase. provided the following conditions are met: the unit was professionally installed and serviced by an authorized HAWK dealer; the unit will be professionally reinstalled in the vehicle in which it was originally installed by an authorized HAWK dealer; and the unit is returned to HAWK, shipping prepaid with a legible copy of the bill of sale or other dated proof of purchase bearing the following information: consumer’s name, telephone number and address; the authorized dealers name, telephone number and address; complete product description, including accessories; the year, make and model of the vehicle; vehicle license number and vehicle identification number. All components other than the unit, including without limitation the siren, the remote transmitters and the associated sensors and accessories, carry a one-year warranty from the date of purchase of the same. This warranty is non-transferable altered, the unit has been modified or used in a manner contrary to its intended purpose; the unit has been damaged by accident, unreasonable use, neglect, improper service, installation or other causes not arising out of defects in materials or construction. The warranty does not cover damage to the unit caused by installation or removal of the unit. HAWK, in its sole discretion, will determine what constitutes excessive damage and may refuse the return of any unit with excessive damage. TO THE MAXIMUM EXTENT ALLOWED BY LAW, ALL WARRANTIES, INCLUDING BUT NOT LIMITED TO EXPRESS WARRANTY, IMPLIED WARRANTY, WARRANTY OF MERCHANTABILITY, FITNESS FOR PARTICULAR PURPOSE AND WARRANTY OF NON-INFRINGEMENT OF INTELLECTUAL PROPERTY, ARE EXPRESSLY EXCLUDED; AND HAWK NEITHER ASSUMES NOR AUTHORIZES ANY PERSON OR ENTITY TO ASSUME FOR IT ANY DUTY, OBLIGATION OR LIABILITY IN CONNECTION WITH ITS PRODUCTS. HAWK DISCLAIMS AND HAS ABSOLUTELY NO LIABILITY FOR ANY AND ALL ACTS OF THIRD PARTIES INCLUDING ITS AUTHORIZED DEALERS OR INSTALLERS. HAWK SECURITY SYSTEMS, INCLUDING THIS UNIT, ARE DETERRENTS AGAINST POSSIBLE THEFT. HAWK IS NOT OFFERING A GUARANTEE OR INSURANCE AGAINST VANDALISM, DAMAGE OR THEFT OF THE AUTOMOBILE, ITS PARTS OR CONTENTS; AND HEREBY EXPRESSLY DISCLAIMS ANY LIABILITY WHATSOEVER, INCLUDING WITHOUT LIMITATION, LIABILITY FOR THEFT, DAMAGE AND/OR VANDALISM. THIS WARRANTY DOES NOT COVER LABOUR COSTS FOR MAINTENANCE, REMOVAL OR REINSTALLATION OF THE UNIT OR ANY CONSEQUENTIAL DAMAGES OF ANY KIND. IN THE EVENT OF A CLAIM OR A DISPUTE INVOLVING HAWK OR ITS SUBSIDIARY, THE PROPER VENUE SHALL BE ENGLAND & WALES . THE MAXIMUM RECOVERY UNDER ANY CLAIM AGAINST HAWK SHALL BE STRICTLY LIMITED TO THE AUTHORIZED HAWK DEALER’S PURCHASE PRICE OF THE UNIT. HAWK SHALL NOT BE RESPONSIBLE FOR ANY DAMAGES WHATSOEVER, INCLUDING BUT NOT LIMITED TO, ANY CONSEQUENTIAL DAMAGES, INCIDENTAL DAMAGES, DAMAGES FOR THE LOSS OF TIME, LOSS OF EARNINGS, COMMERCIAL LOSS, LOSS OF ECONOMIC OPPORTUNITY AND THE LIKE. NOT WITHSTANDING THE ABOVE, THE MANUFACTURER DOES OFFER A LIMITED ONE YEAR WARRANTY TO REPLACE OR REPAIR THE CONTROL MODULE AS DESCRIBED ABOVE.

Manufacturer and Exporter
Commercial electronics®

264 Haydon's Road
Wimbledon
London SW19 8TT
Telephone: 0208 404 7105
Fax: 0208 404 7104
Web: www.hawkcaralarm.com

Est. 1987



www.hawkcaralarm.com
info@hawkcaralarm.com